







37 Korkeuksia ja pinta-aloja

Täydennä taulukko. Muista pyöristyssäännöt.

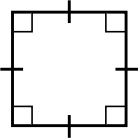
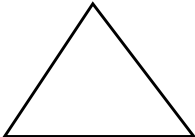
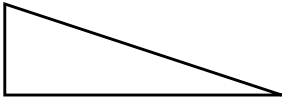
Kuvio	kanta	korkeus	pinta-ala
	4,5 cm	3,8 cm	
	6 cm		30 cm ²
			64 cm ²
	5,0 cm	3,5 cm	
	24 cm		88 cm ²
		17 m	178,5 m ² ≈
	1,6 m	1,4 m	
	5,4 m		24,84 m ² ≈
	3,25 m	4,75 m	
	13 m		1,95 a ≈

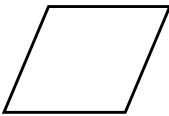
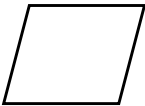
39 Tasokuvioiden pinta-aloja

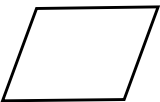
Laske pinta-ala ja tarkista vastaus laatikosta.

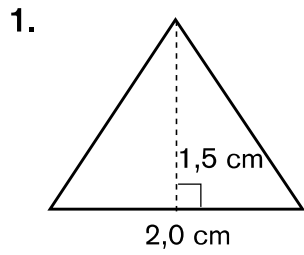

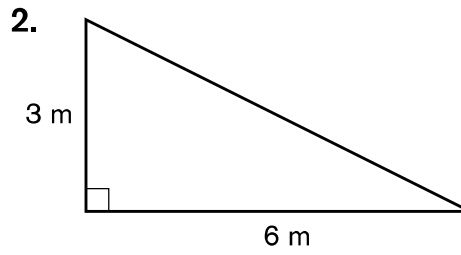

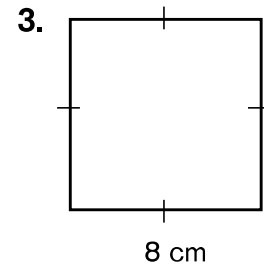

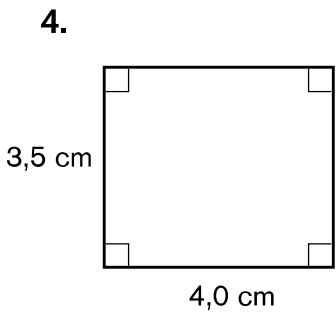

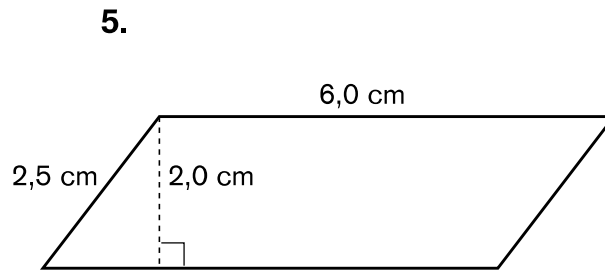

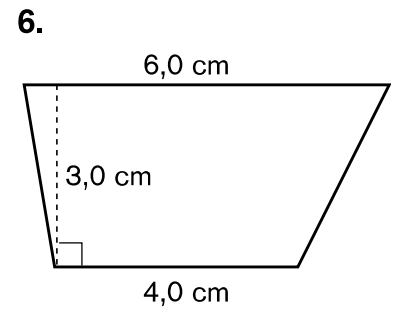

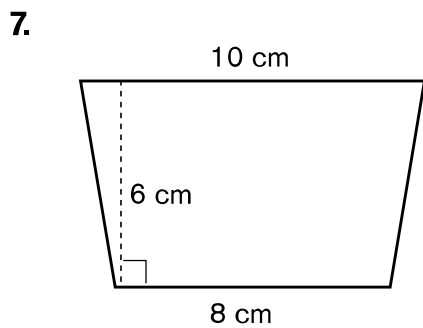

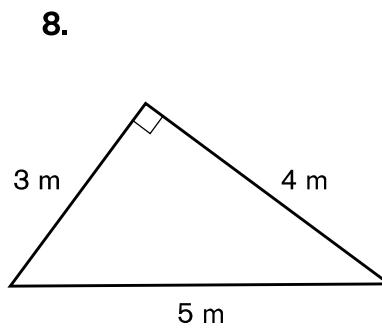

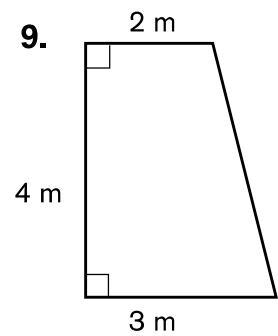

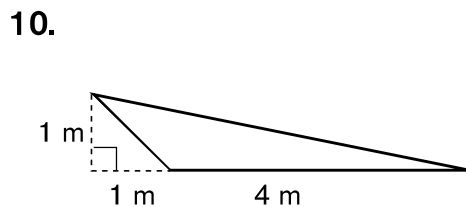

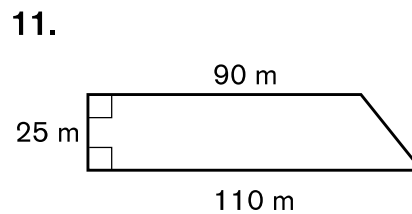

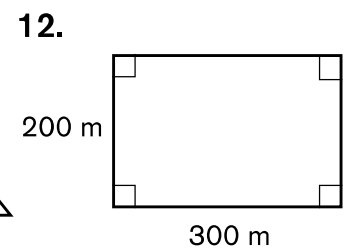

14 cm ²	25 a	1,5 cm ²	12 cm ²	15 cm ²	6 m ²
64 cm ²	9 m ²	54 cm ²	10 m ²	6 ha	2 m ²