

1. Vä-ri-tä sa-maan jouk-koon kuu-lu-vat.

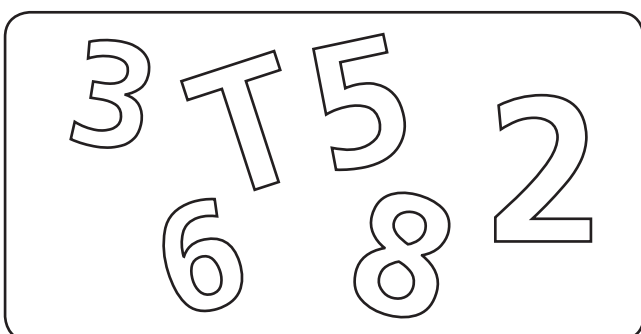

Kek-si it-se.

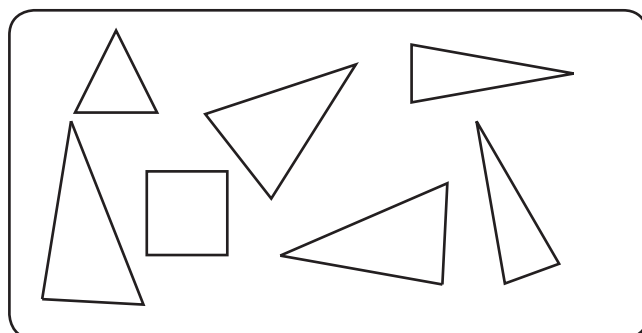
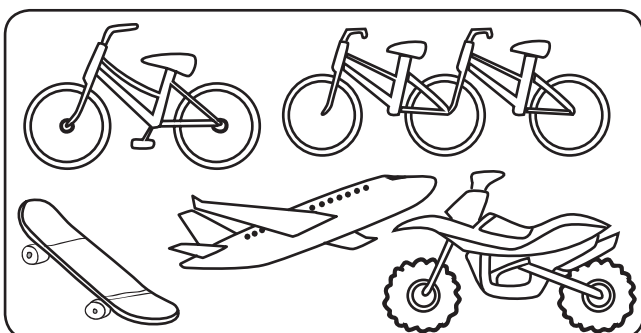
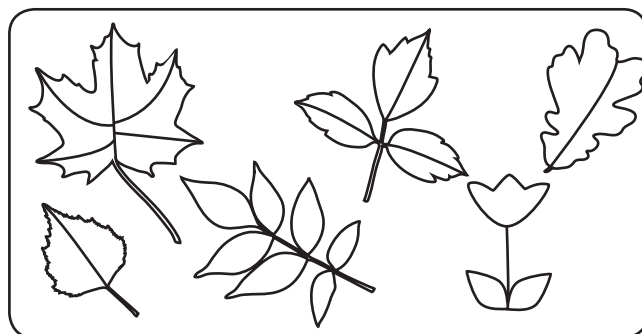
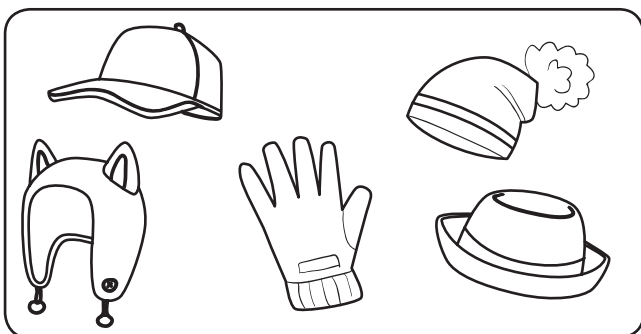
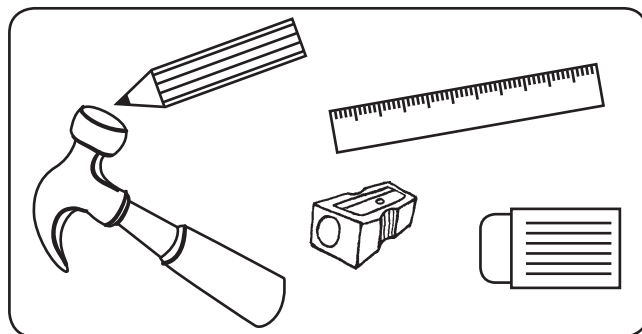
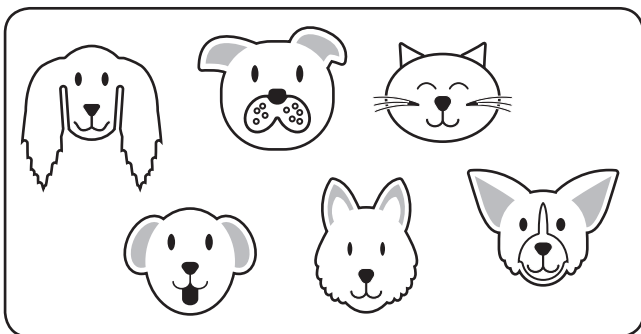
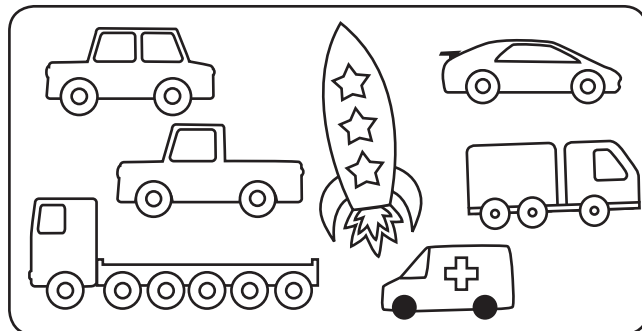
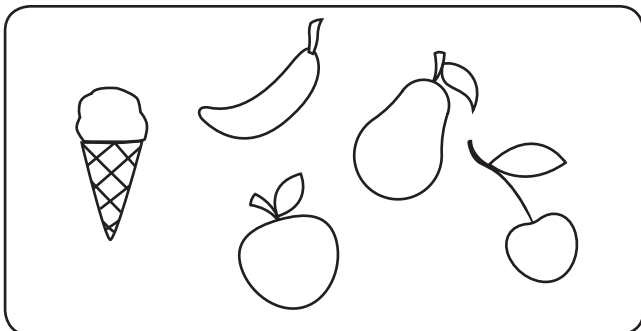