

JYVÄSKYLÄ

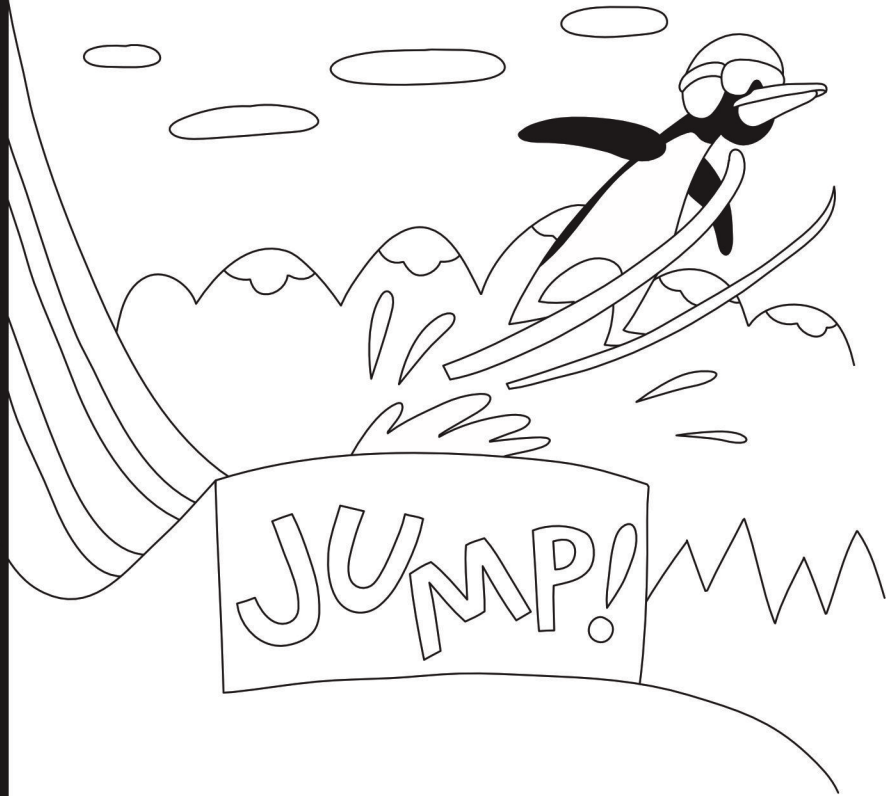

J



JYVÄSKYLÄ



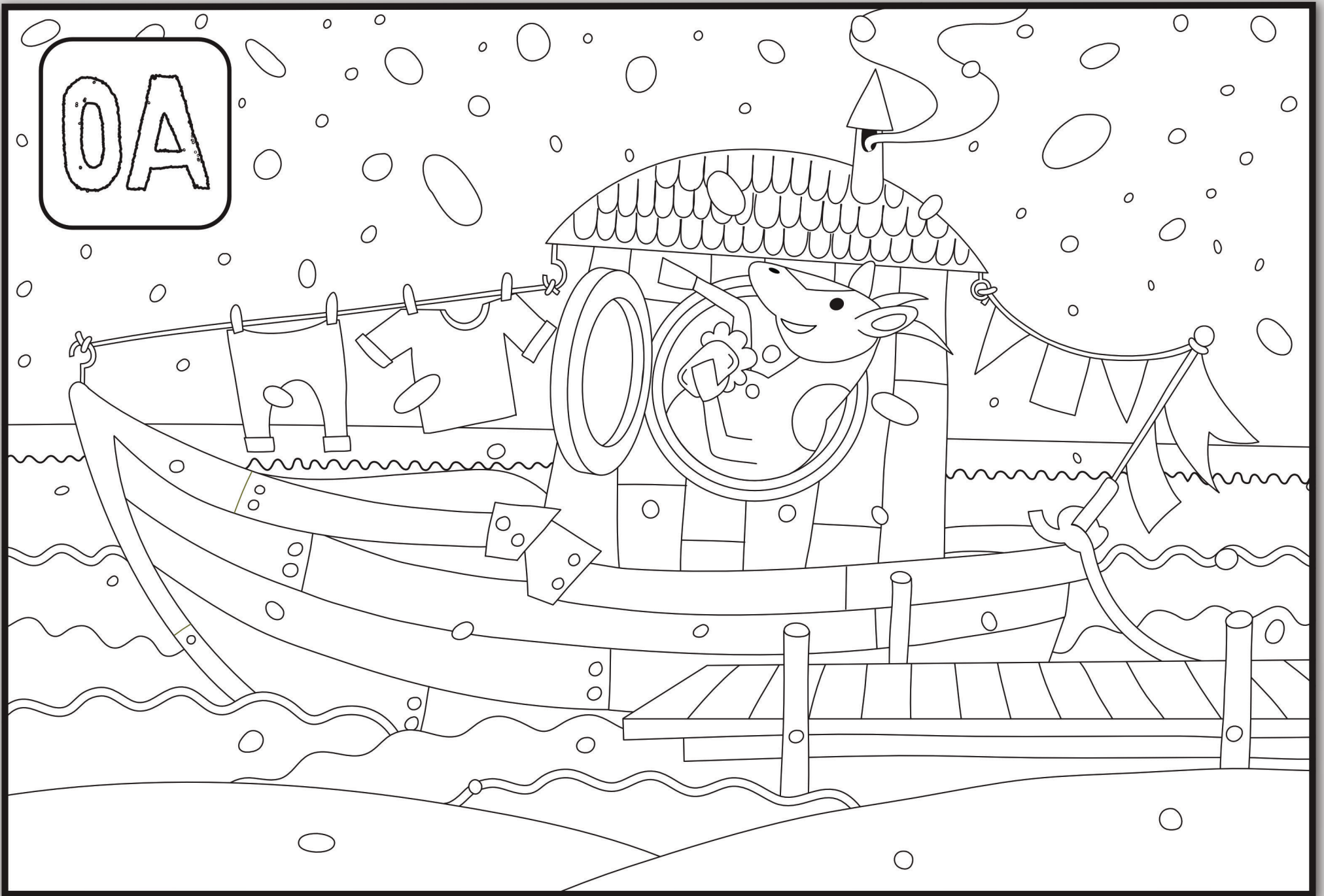

JYVÄSKYLÄ



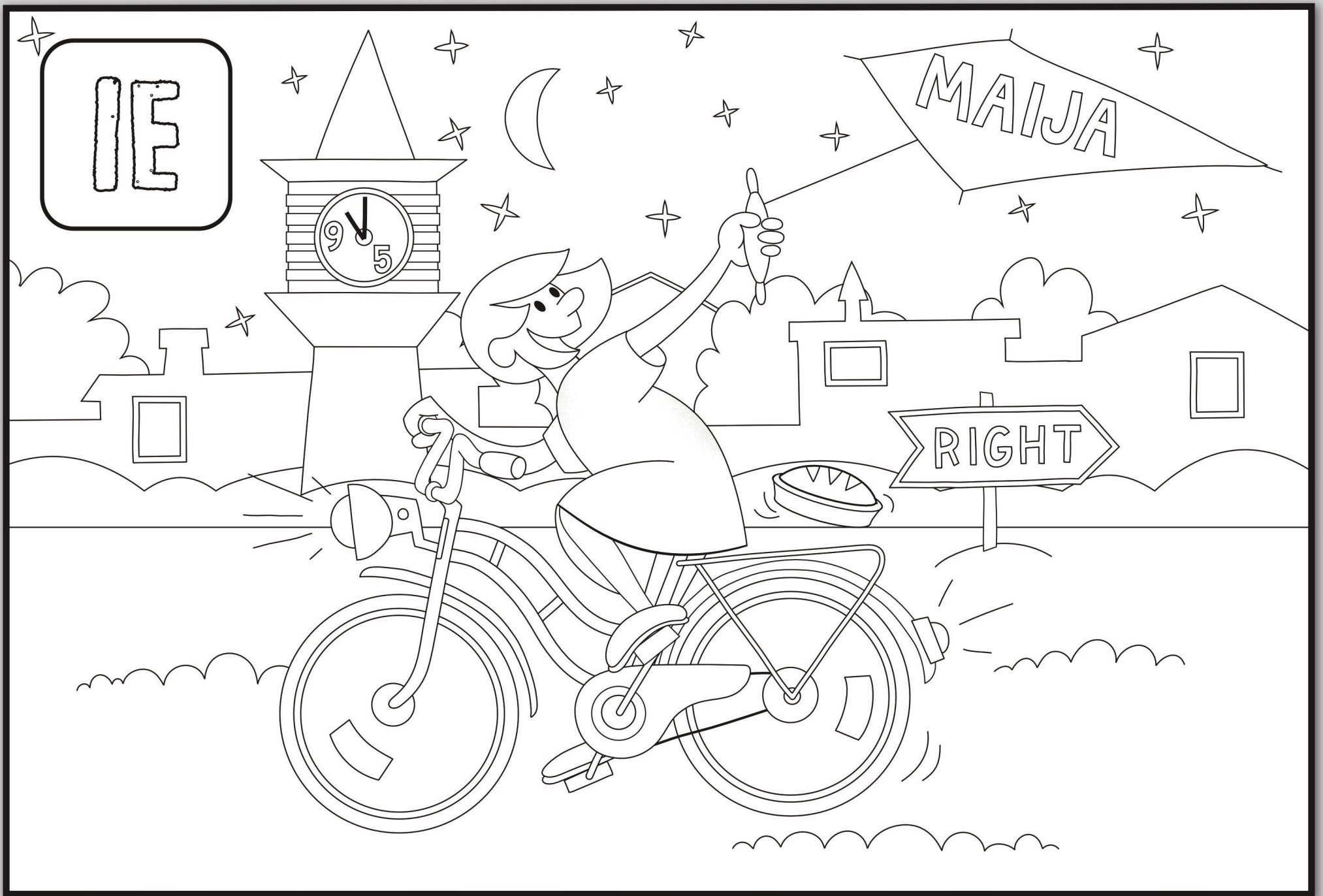

JYVÄSKYLÄ



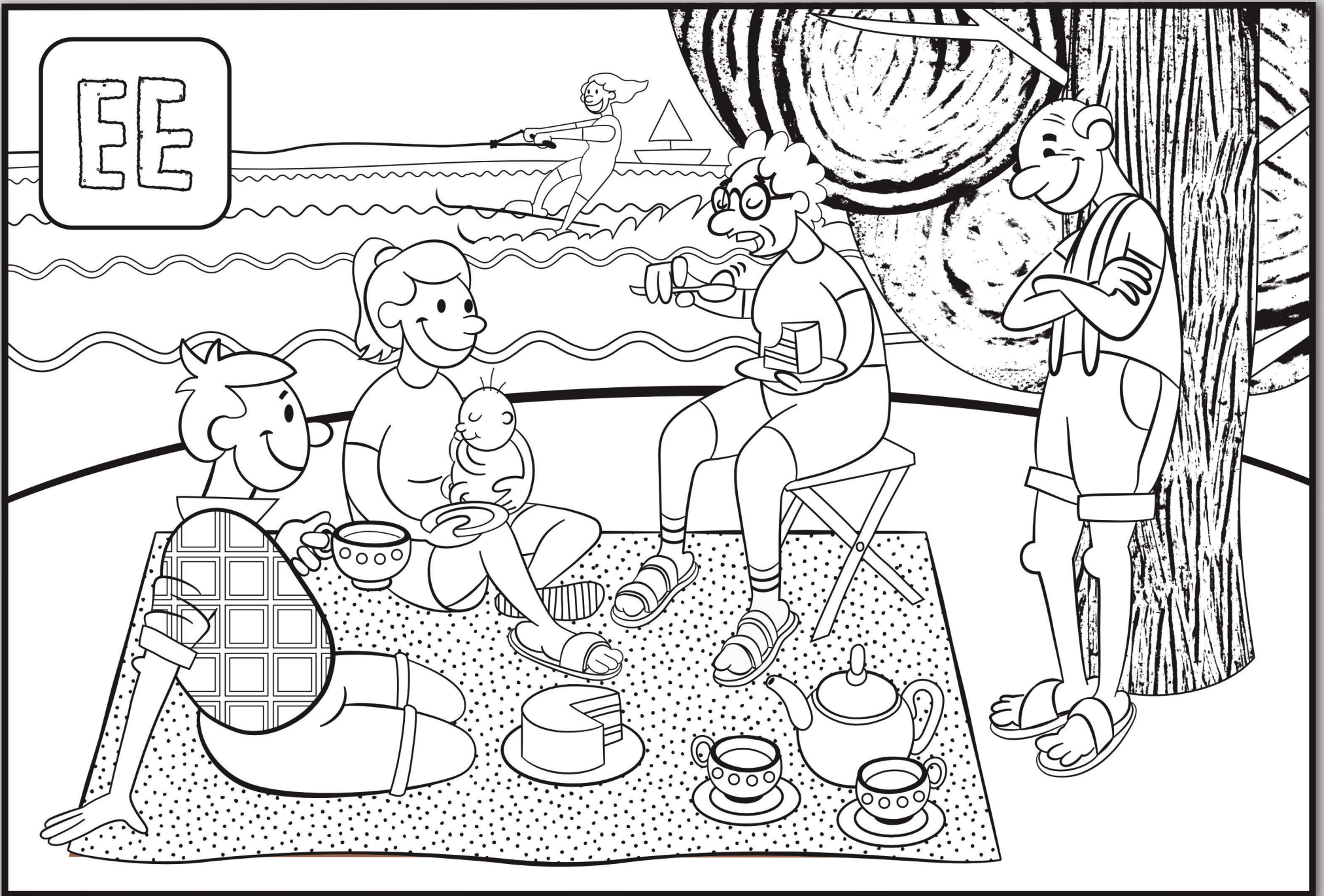

JYVÄSKYLÄ



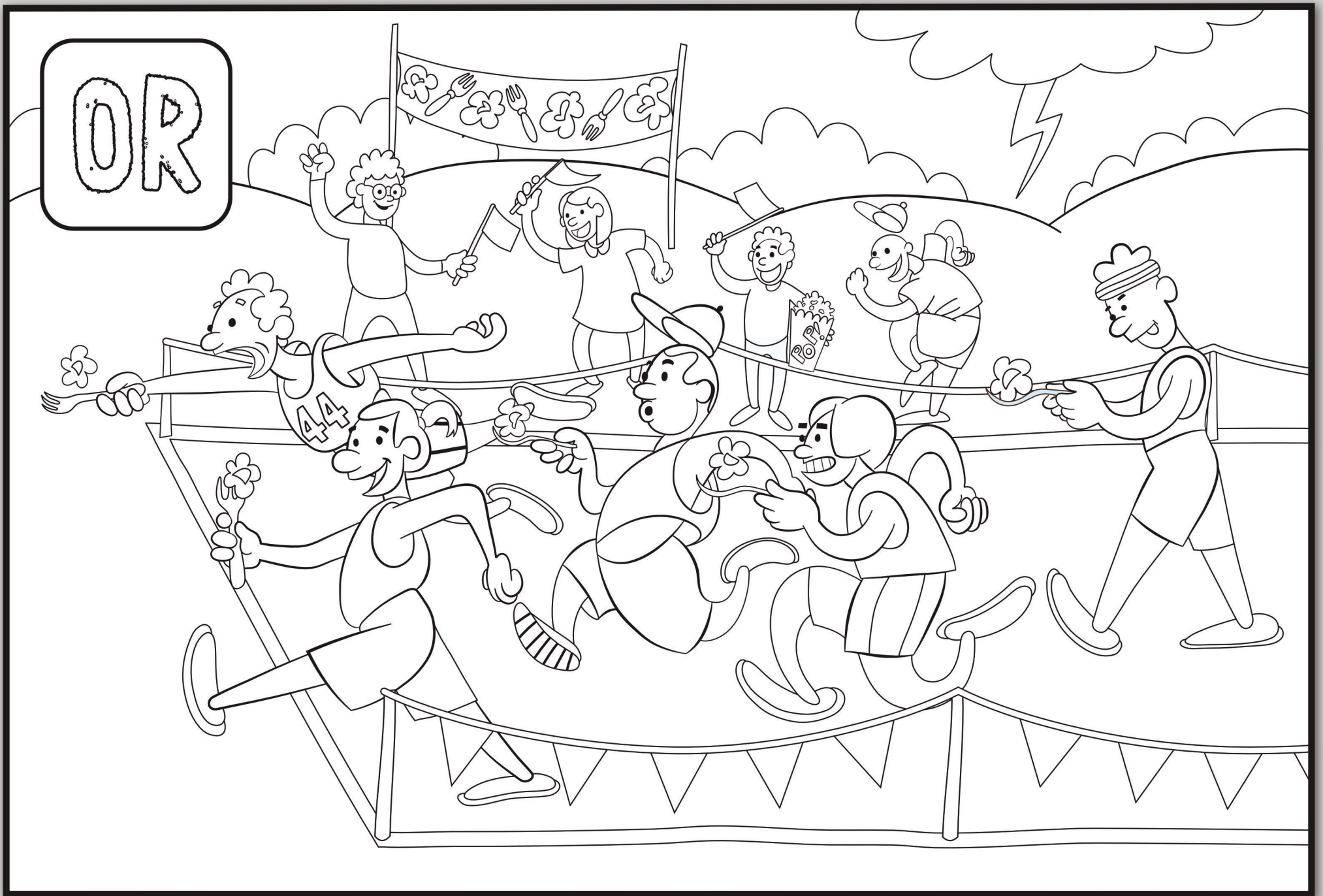

JYVÄSKYLÄ



Z

SHOULDERS

KNEES

TOES

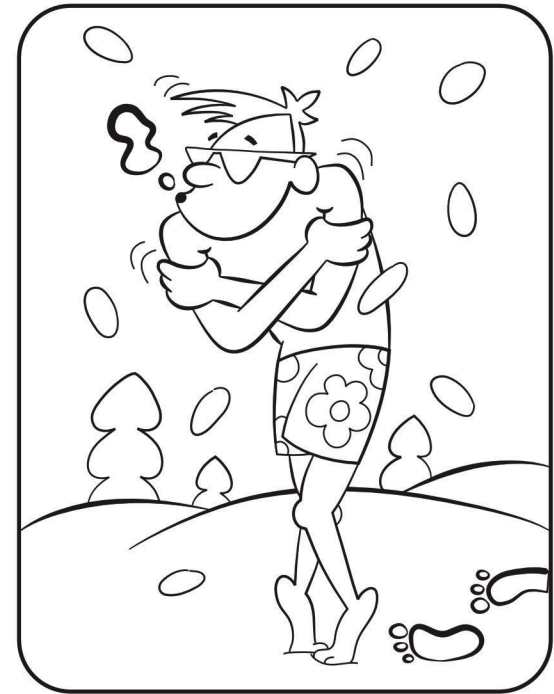
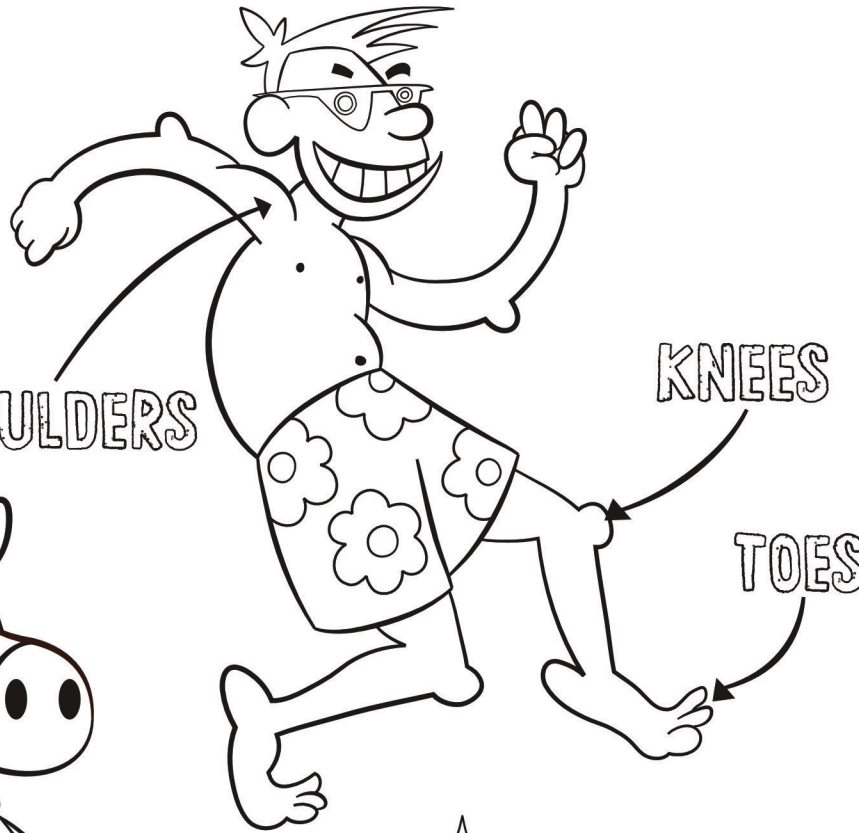
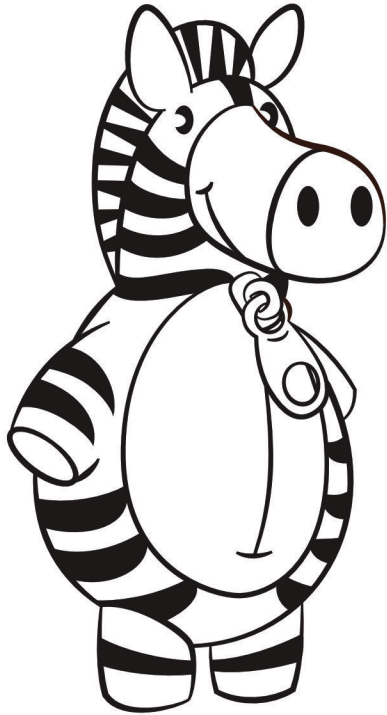



NG

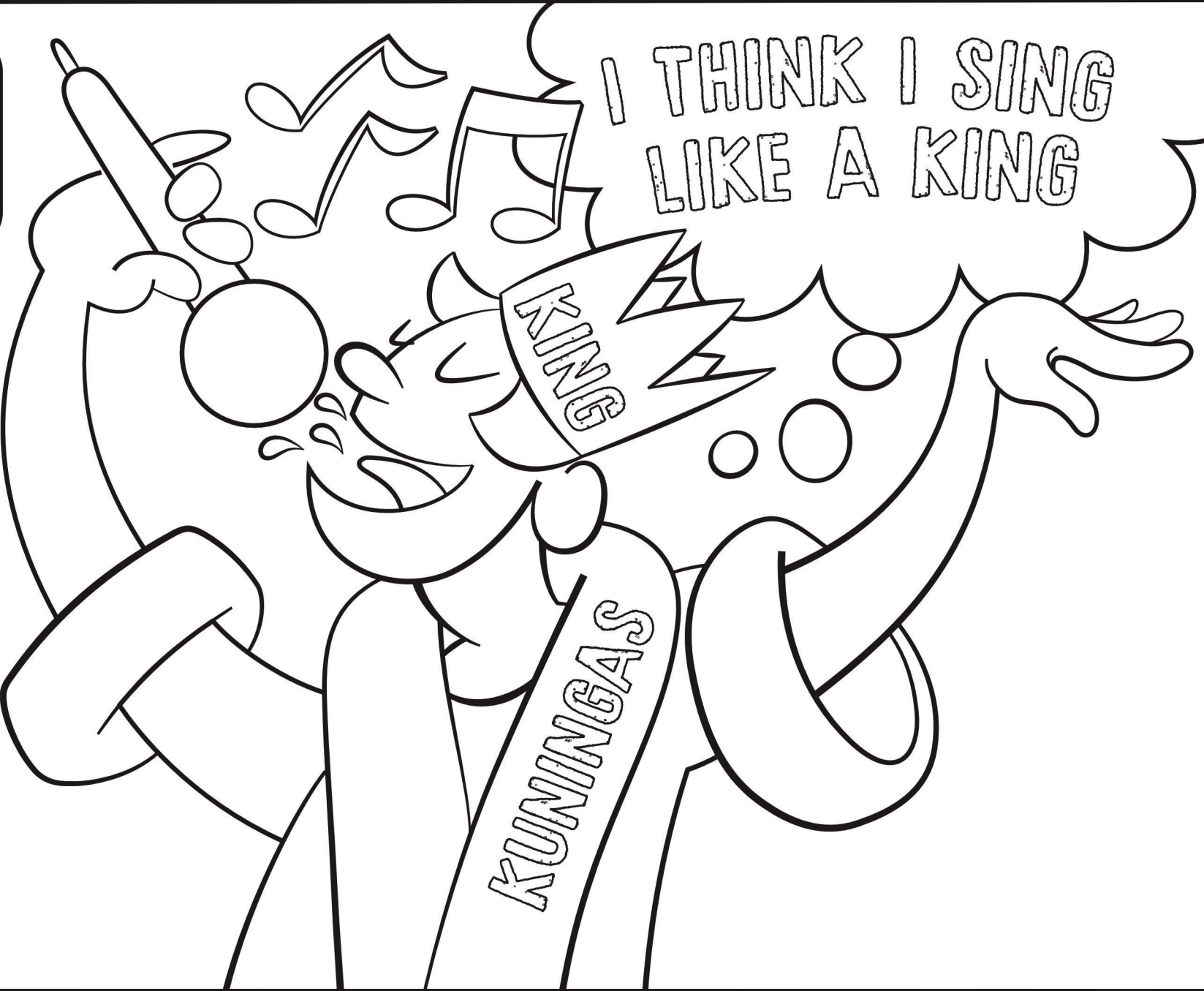

JYVÄSKYLÄ



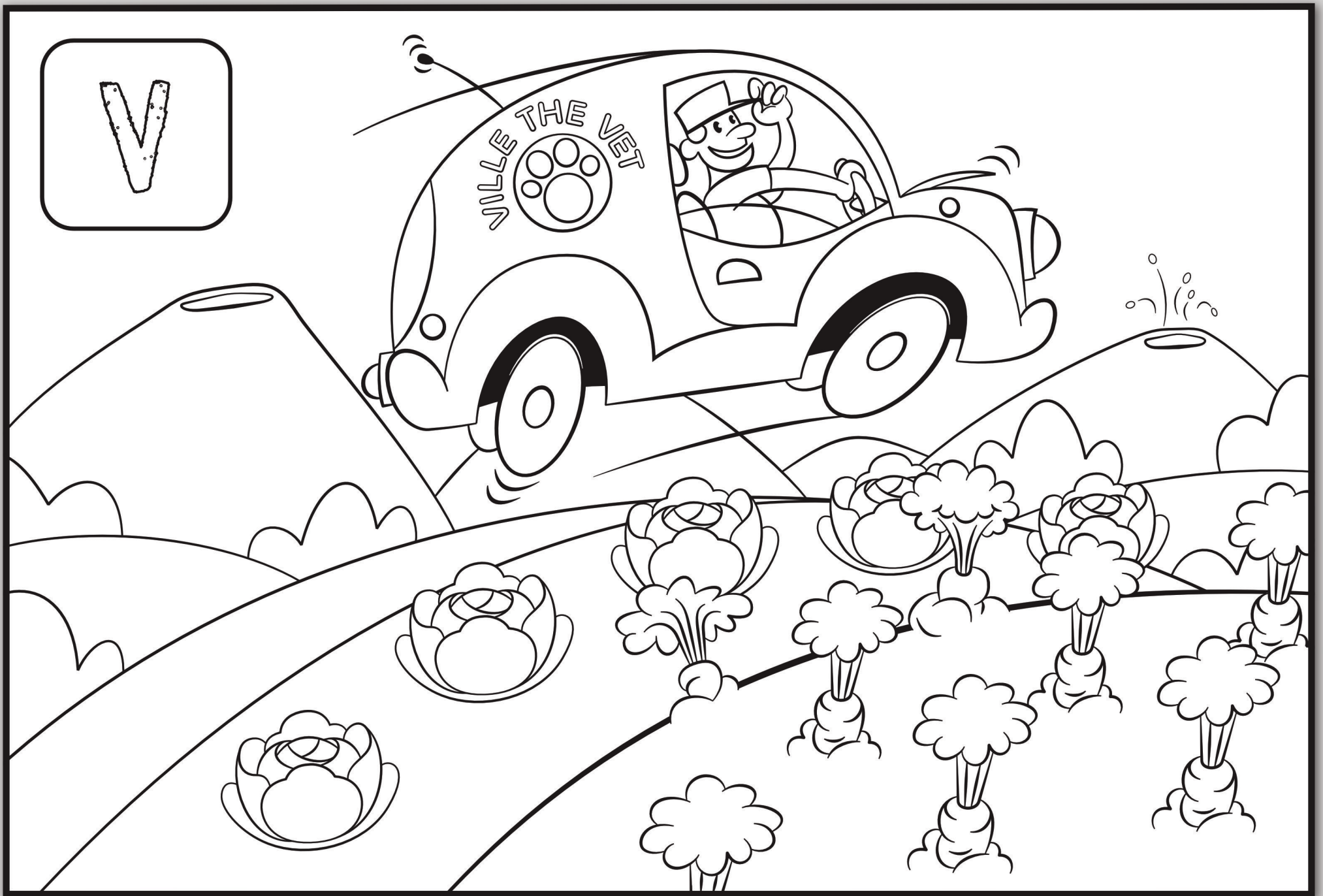

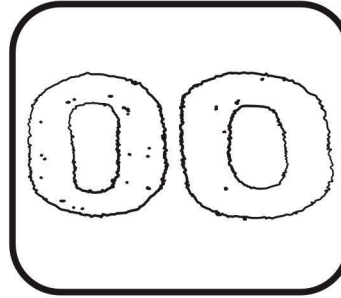
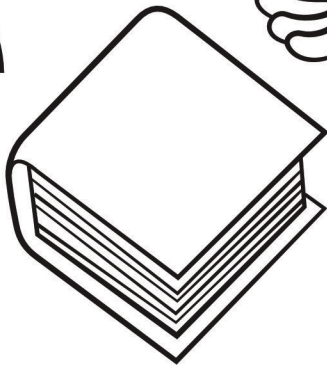
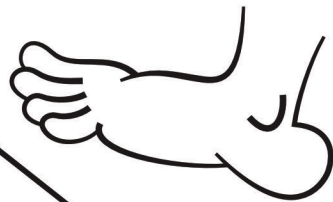
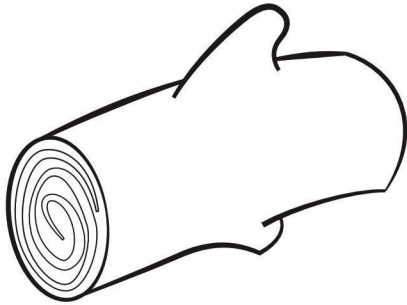
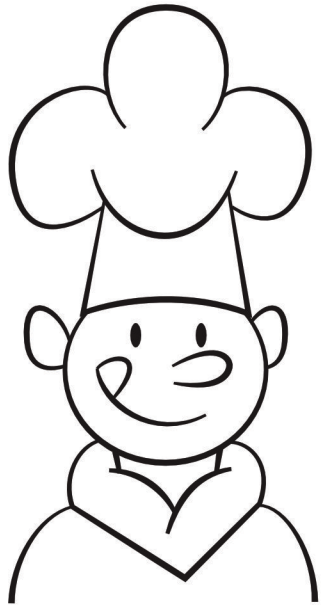
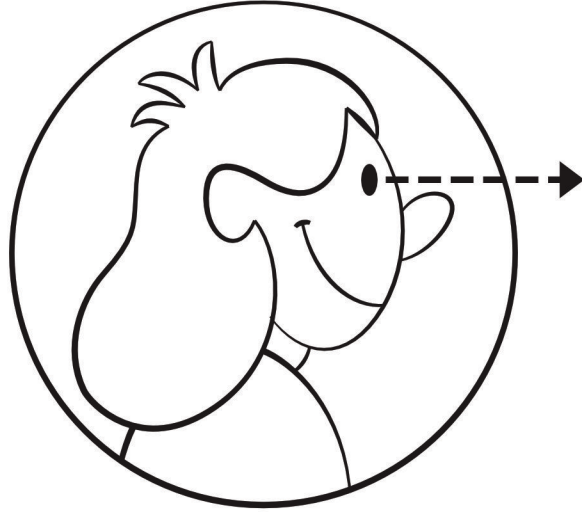
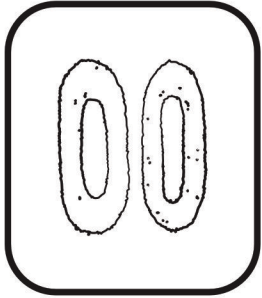

BLUE

2

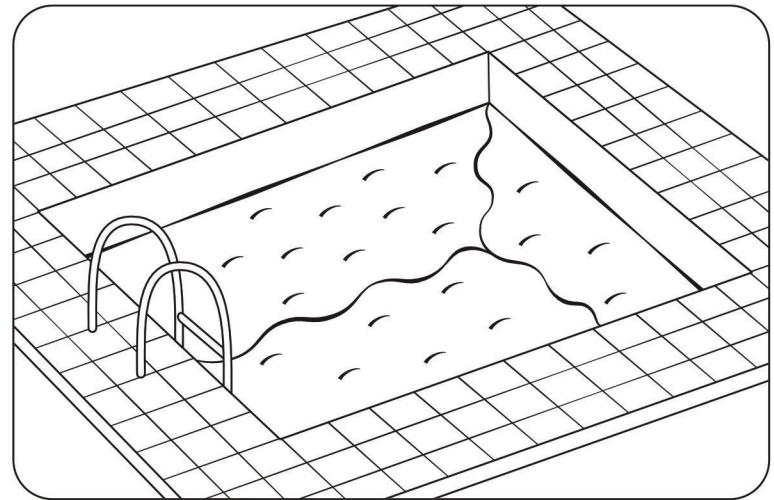
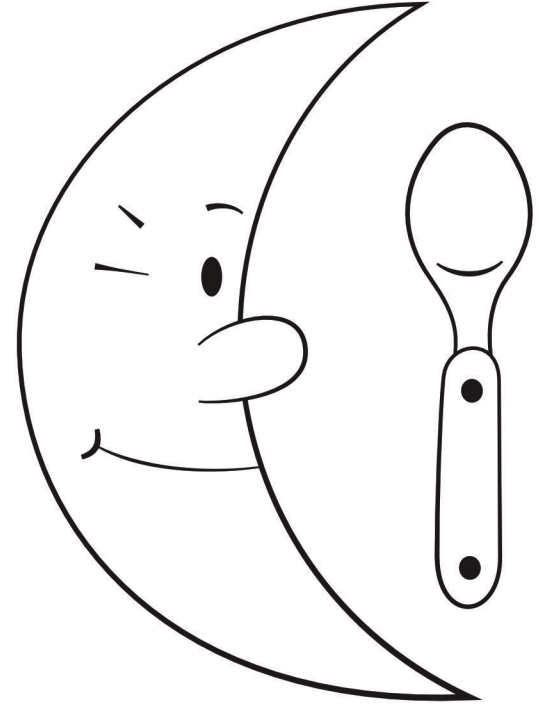

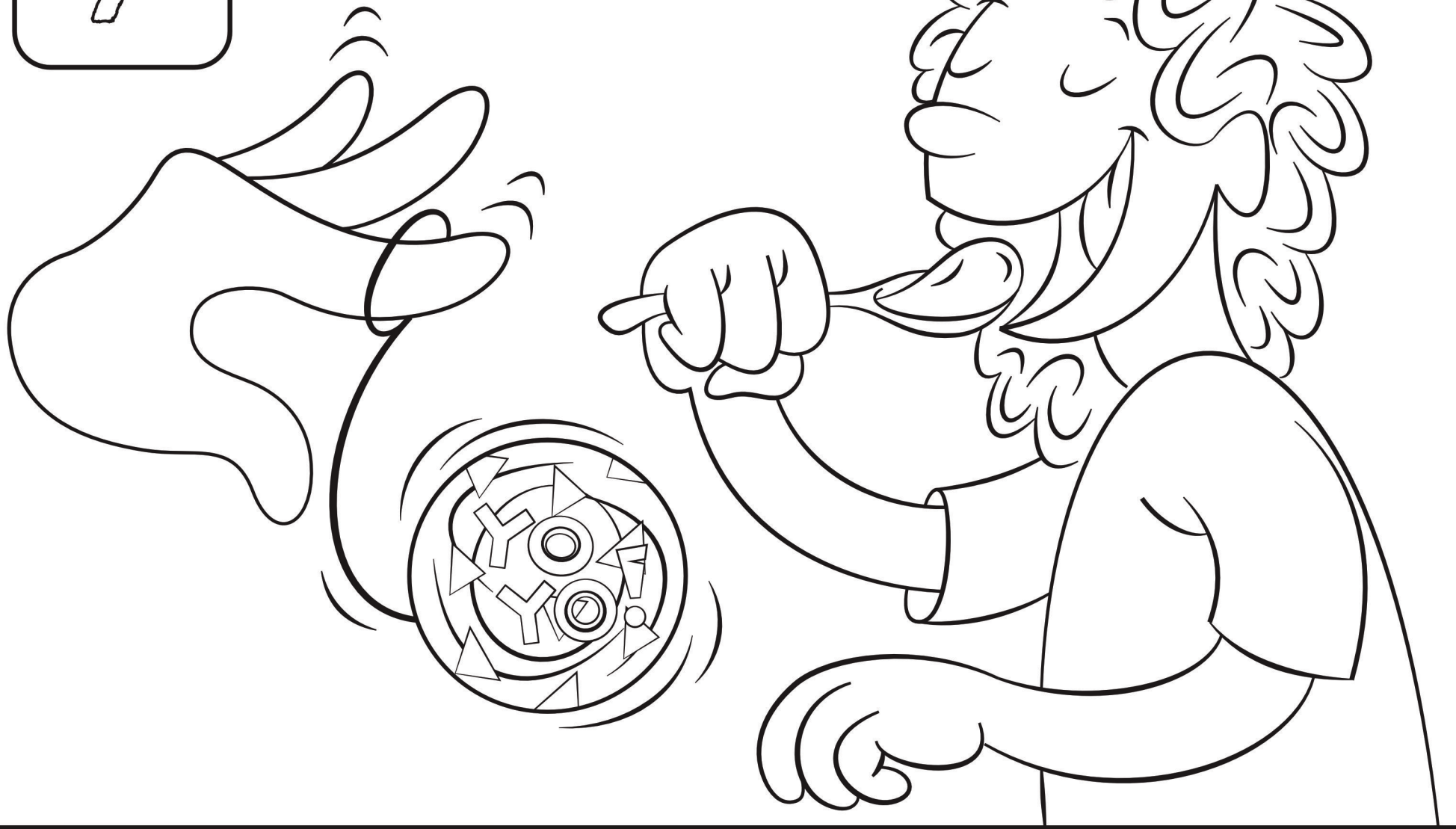
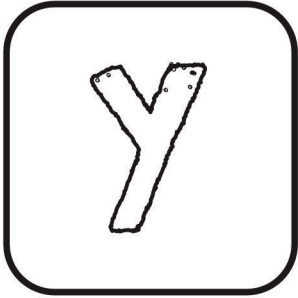

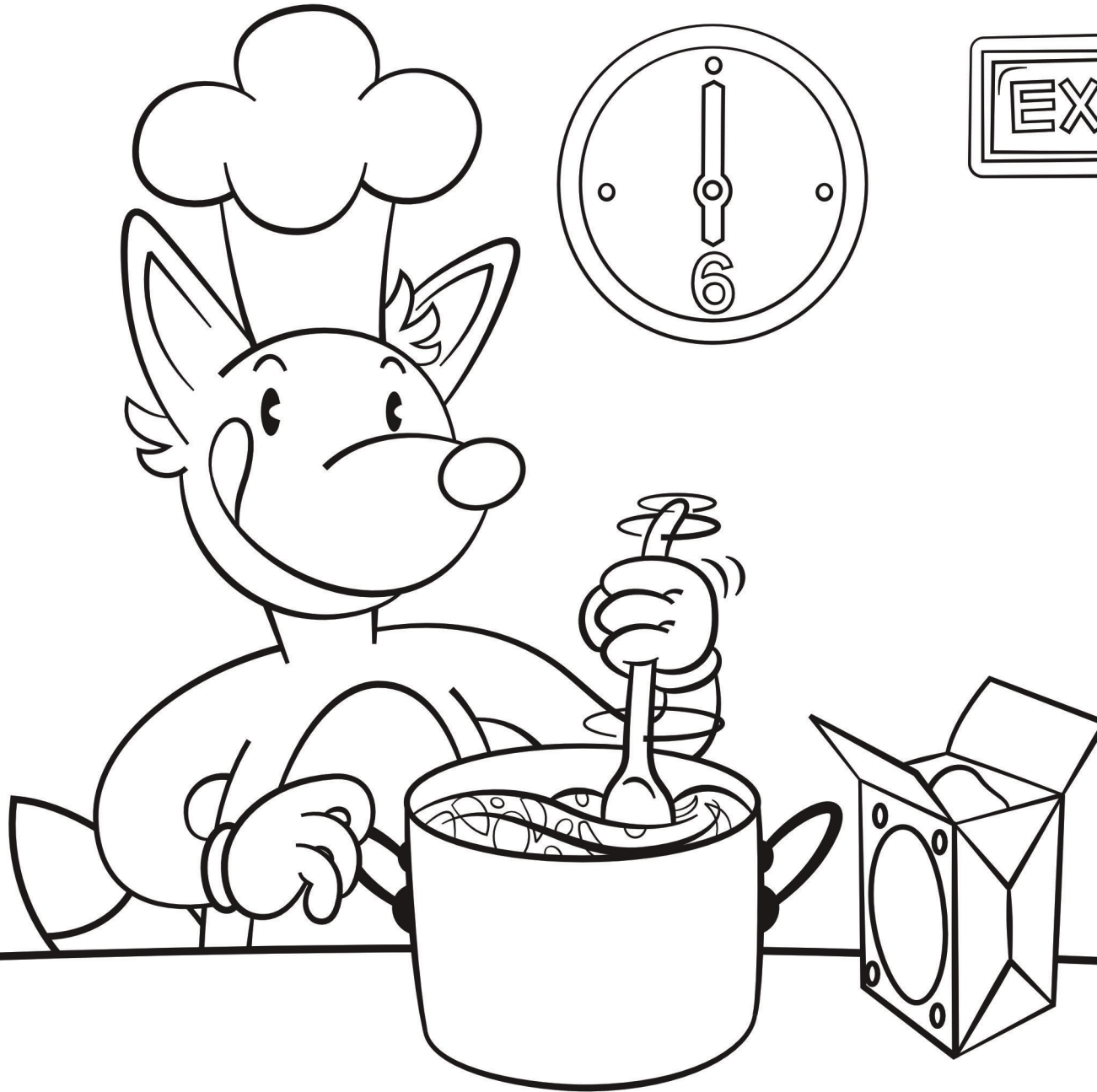
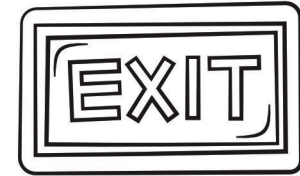
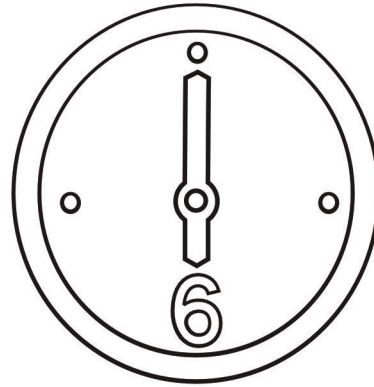
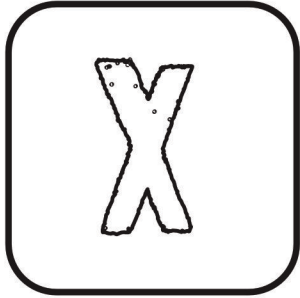

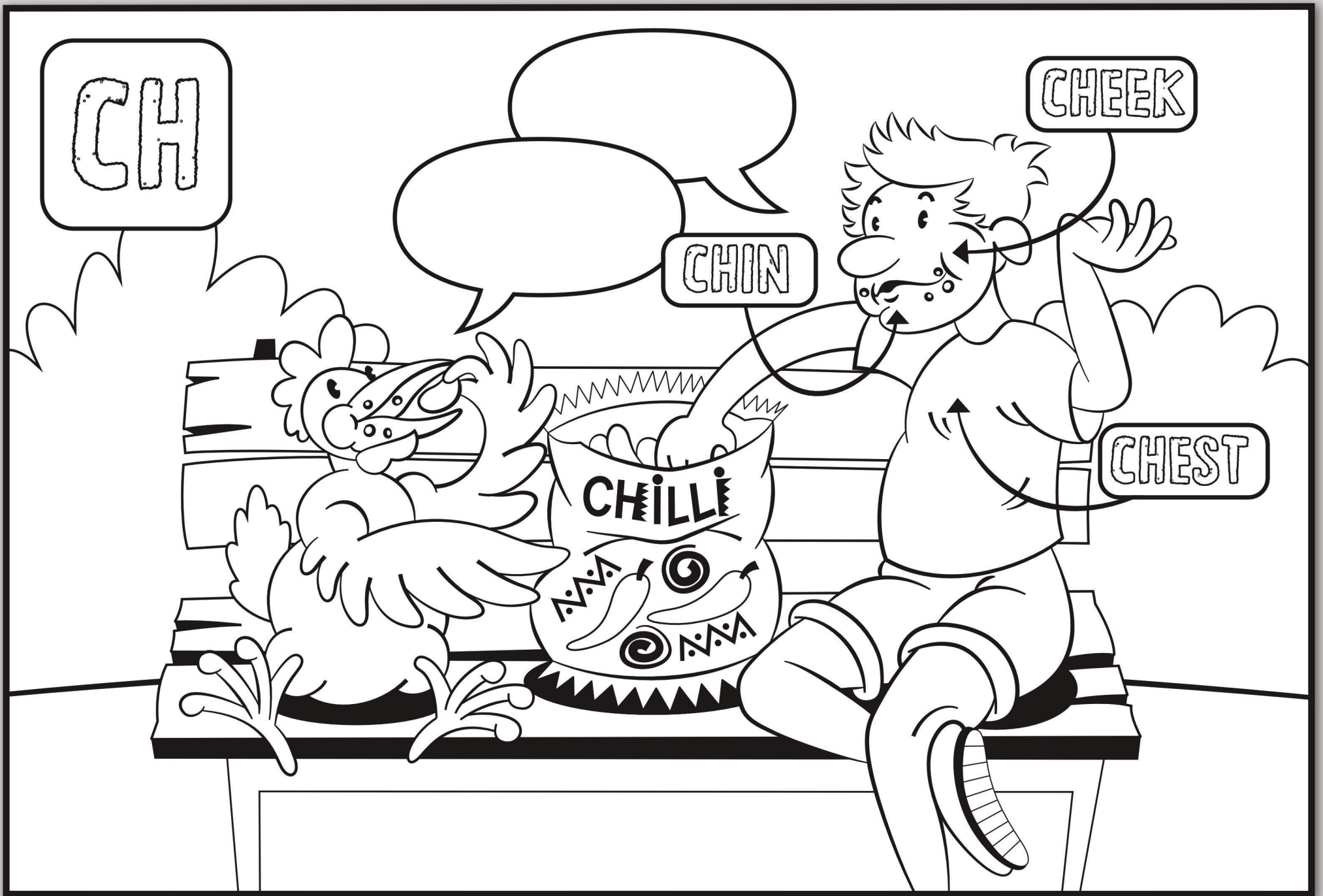

SH

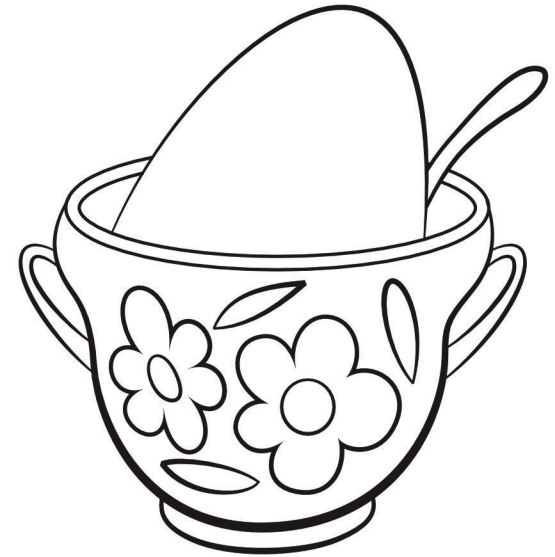
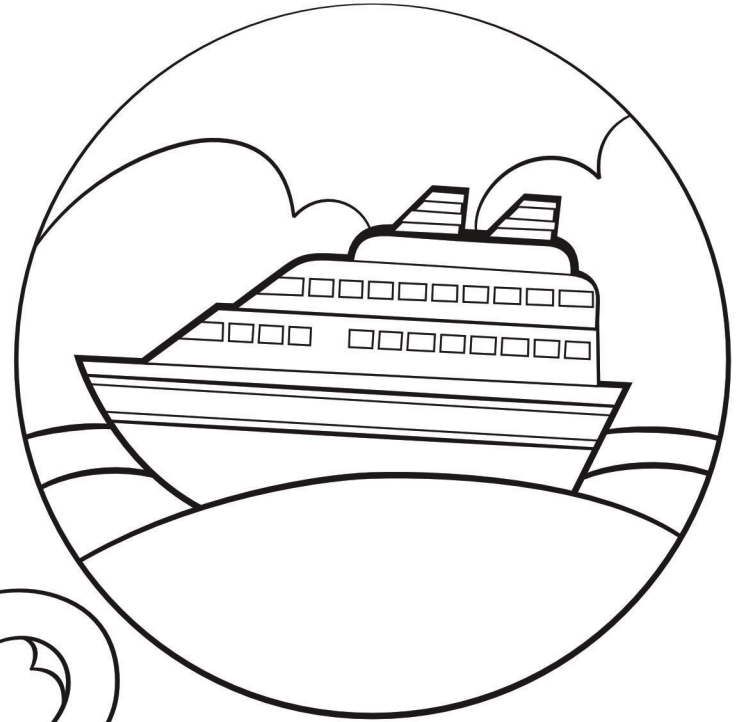
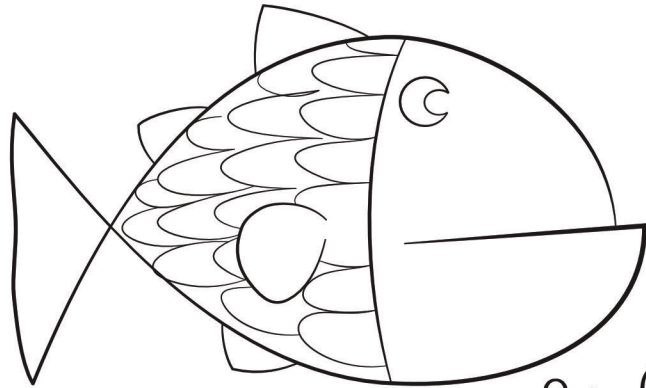

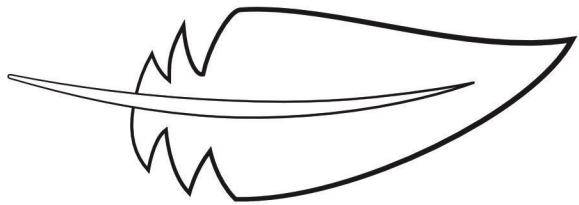

FEATHER

TH

3
THREE

↑
NORTH

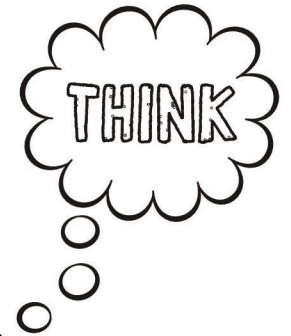

SMOOTHIE

THIS → ○

THAT → ○

THEM → ○○○

BROTHER ○

SOINNILLINEN

TEETH

THUMB



SOINNITON



THICK



THIN



QU

QUACK!
QUACK!

?

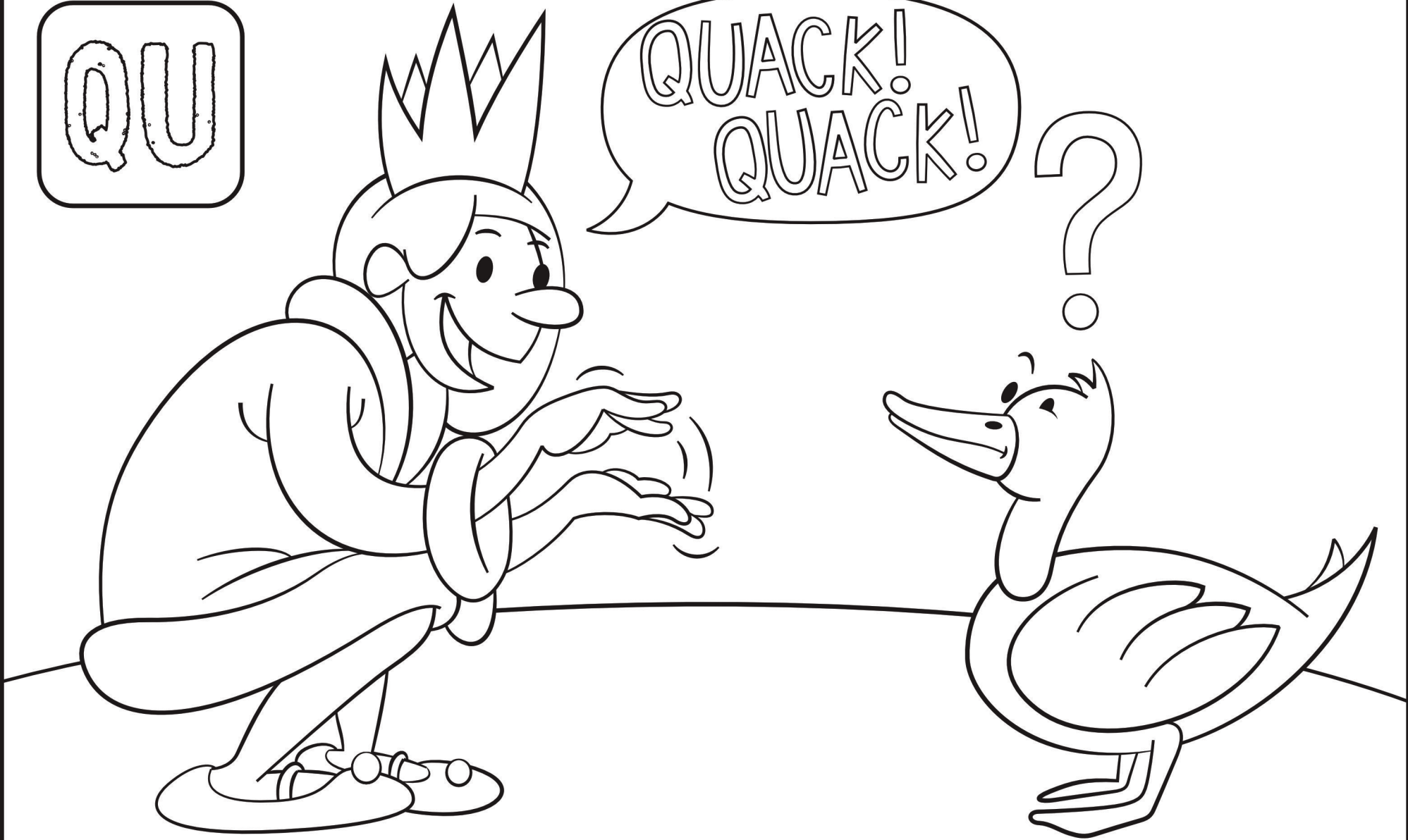

OU

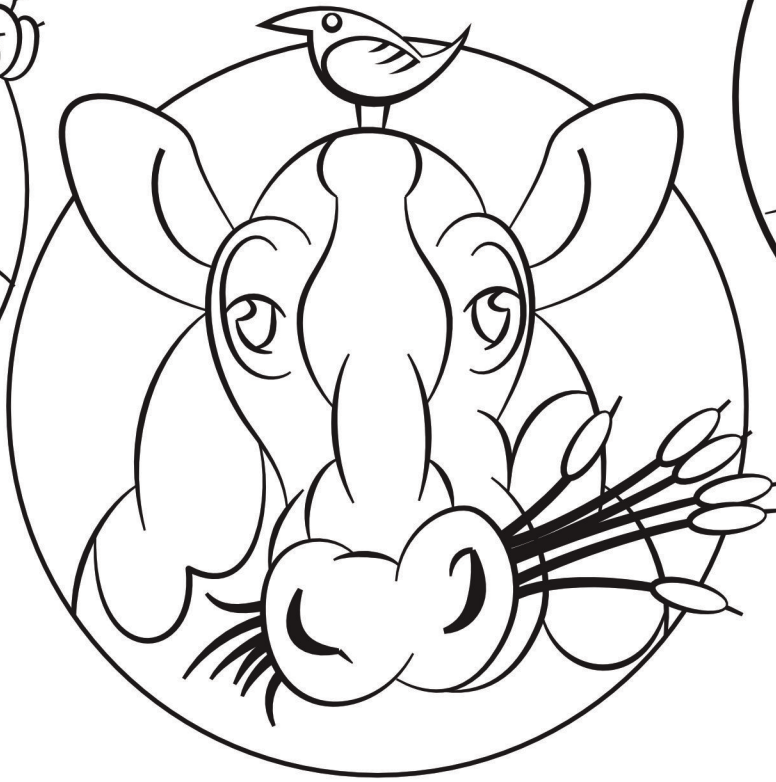
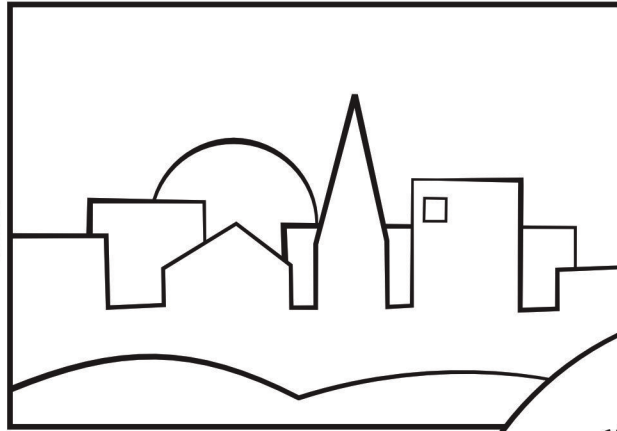

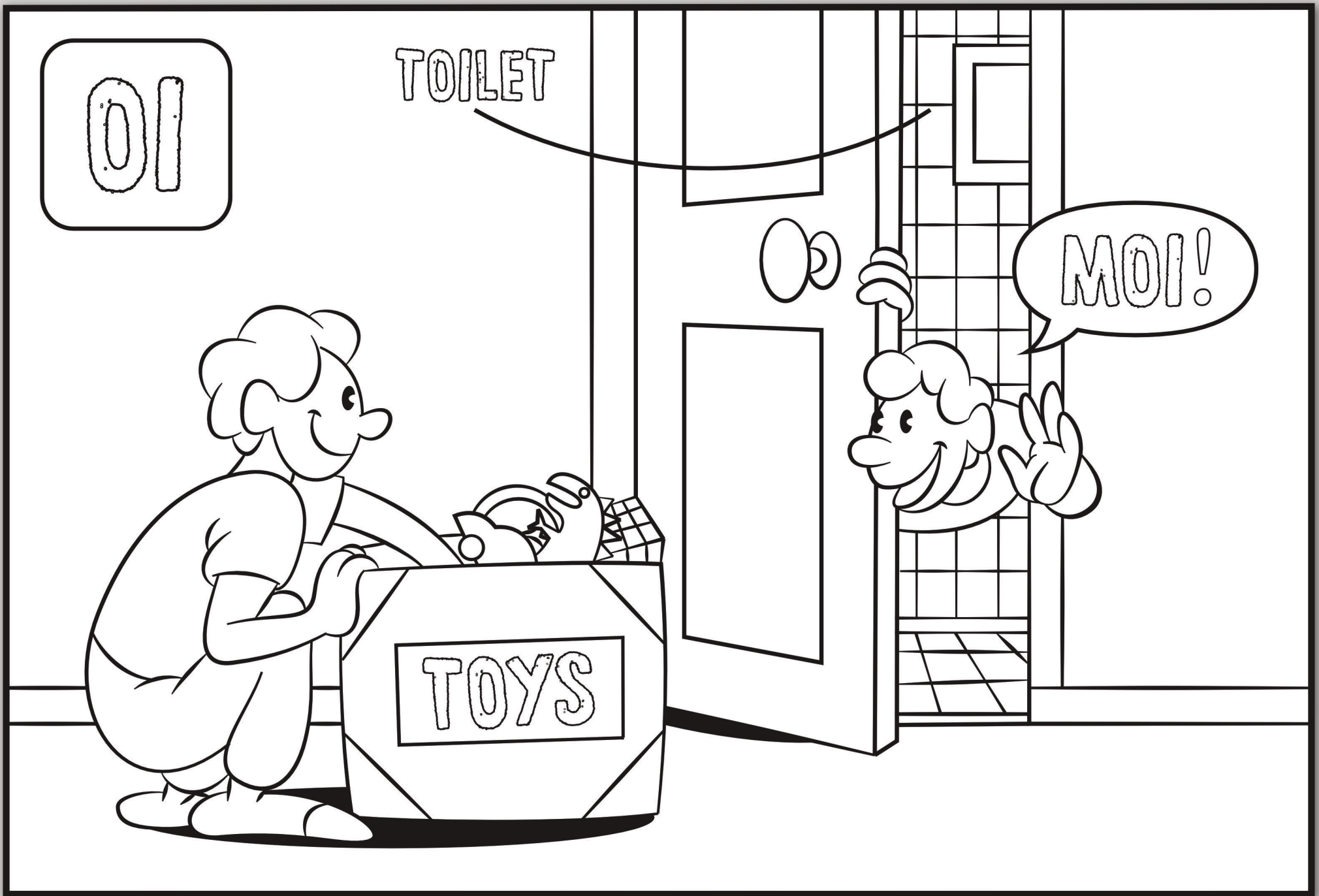

UE

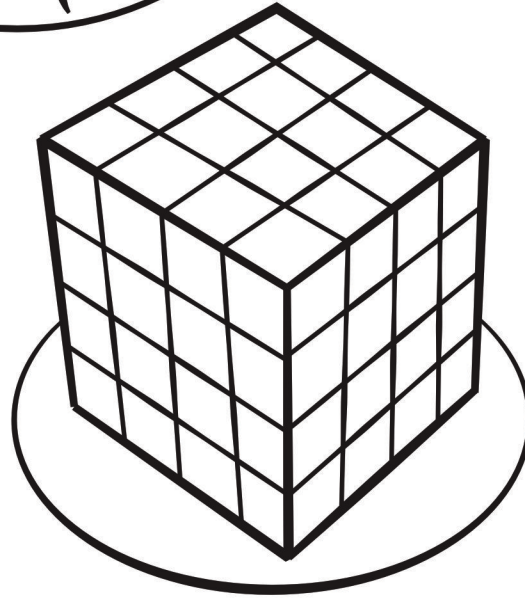
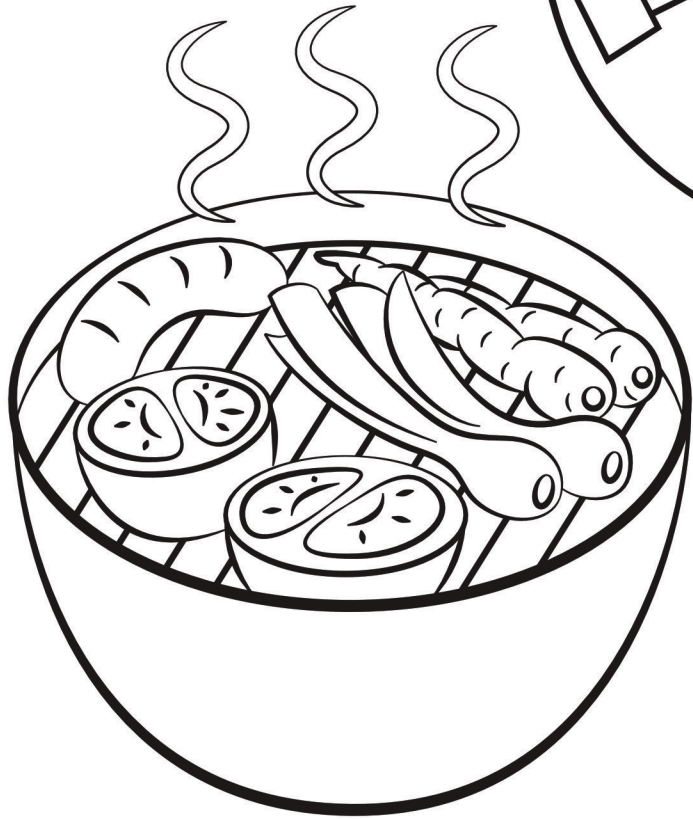



JYVÄSKYLÄ



